



UNIVERSITY OF CAMBRIDGE INTERNATIONAL EXAMINATIONS  
General Certificate of Education  
Advanced Subsidiary Level and Advanced Level

**PHYSICS**

**9702/13**

Paper 1 Multiple Choice

**October/November 2013**

**1 hour**

Additional Materials: Multiple Choice Answer Sheet  
Soft clean eraser  
Soft pencil (type B or HB is recommended)



**READ THESE INSTRUCTIONS FIRST**

Write in soft pencil.

Do not use staples, paper clips, highlighters, glue or correction fluid.

Write your name, Centre number and candidate number on the Answer Sheet in the spaces provided unless this has been done for you.

**DO NOT WRITE IN ANY BARCODES.**

There are **forty** questions on this paper. Answer **all** questions. For each question there are four possible answers **A, B, C** and **D**.

Choose the **one** you consider correct and record your choice in **soft pencil** on the separate Answer Sheet.

**Read the instructions on the Answer Sheet very carefully.**

Each correct answer will score one mark. A mark will not be deducted for a wrong answer.

Any working should be done in this booklet.

Electronic calculators may be used.

This document consists of **23** printed pages and **1** blank page.



**Data**

speed of light in free space,	$c = 3.00 \times 10^8 \text{ m s}^{-1}$
permeability of free space,	$\mu_0 = 4\pi \times 10^{-7} \text{ H m}^{-1}$
permittivity of free space,	$\epsilon_0 = 8.85 \times 10^{-12} \text{ F m}^{-1}$ $(\frac{1}{4\pi\epsilon_0} = 8.99 \times 10^9 \text{ m F}^{-1})$
elementary charge,	$e = 1.60 \times 10^{-19} \text{ C}$
the Planck constant,	$h = 6.63 \times 10^{-34} \text{ J s}$
unified atomic mass constant,	$u = 1.66 \times 10^{-27} \text{ kg}$
rest mass of electron,	$m_e = 9.11 \times 10^{-31} \text{ kg}$
rest mass of proton,	$m_p = 1.67 \times 10^{-27} \text{ kg}$
molar gas constant,	$R = 8.31 \text{ J K}^{-1} \text{ mol}^{-1}$
the Avogadro constant,	$N_A = 6.02 \times 10^{23} \text{ mol}^{-1}$
the Boltzmann constant,	$k = 1.38 \times 10^{-23} \text{ J K}^{-1}$
gravitational constant,	$G = 6.67 \times 10^{-11} \text{ N m}^2 \text{ kg}^{-2}$
acceleration of free fall,	$g = 9.81 \text{ m s}^{-2}$

**Formulae**

uniformly accelerated motion,	$s = ut + \frac{1}{2}at^2$ $v^2 = u^2 + 2as$
work done on/by a gas,	$W = p\Delta V$
gravitational potential,	$\phi = -\frac{Gm}{r}$
hydrostatic pressure,	$p = \rho gh$
pressure of an ideal gas,	$p = \frac{1}{3}\frac{Nm}{V}\langle c^2 \rangle$
simple harmonic motion,	$a = -\omega^2 x$
velocity of particle in s.h.m.,	$v = v_0 \cos \omega t$ $v = \pm \omega \sqrt{(x_0^2 - x^2)}$
electric potential,	$V = \frac{Q}{4\pi\epsilon_0 r}$
capacitors in series,	$1/C = 1/C_1 + 1/C_2 + \dots$
capacitors in parallel,	$C = C_1 + C_2 + \dots$
energy of charged capacitor,	$W = \frac{1}{2}QV$
resistors in series,	$R = R_1 + R_2 + \dots$
resistors in parallel,	$1/R = 1/R_1 + 1/R_2 + \dots$
alternating current/voltage,	$x = x_0 \sin \omega t$
radioactive decay,	$x = x_0 \exp(-\lambda t)$
decay constant,	$\lambda = \frac{0.693}{t_{\frac{1}{2}}}$

1 Which estimate is realistic?

- A The kinetic energy of a bus travelling on an expressway is 30 000 J.
- B The power of a domestic light is 300 W.
- C The temperature of a hot oven is 300 K.
- D The volume of air in a car tyre is  $0.03 \text{ m}^3$ .

2 Which unit is equivalent to the coulomb?

- A ampere per second
- B joule per volt
- C watt per ampere
- D watt per volt

3 Two forces of equal magnitude are represented by two coplanar vectors. One is directed eastwards and the other is directed northwards.

What is the direction of a single force that will balance these two forces?

- A towards the north-east
- B towards the north-west
- C towards the south-east
- D towards the south-west

**Space for working**

- 4 The spring constant  $k$  of a coiled wire spring is given by the equation

$$k = \frac{Gr^4}{4nR^3}$$

where  $r$  is the radius of the wire,  $n$  is the number of turns of wire and  $R$  is the radius of each of the turns of wire. The quantity  $G$  depends on the material from which the wire is made.

What is a suitable unit for  $G$ ?

- A**  $\text{Nm}^{-2}$       **B**  $\text{Nm}^{-1}$       **C**  $\text{Nm}$       **D**  $\text{Nm}^2$

**Space for working**

- 5 An uncalibrated analogue voltmeter P is connected in parallel with another voltmeter Q which is known to be accurately calibrated. For a range of values of potential difference (p.d.), readings are taken from the two meters.

The diagram shows the calibration graph obtained.

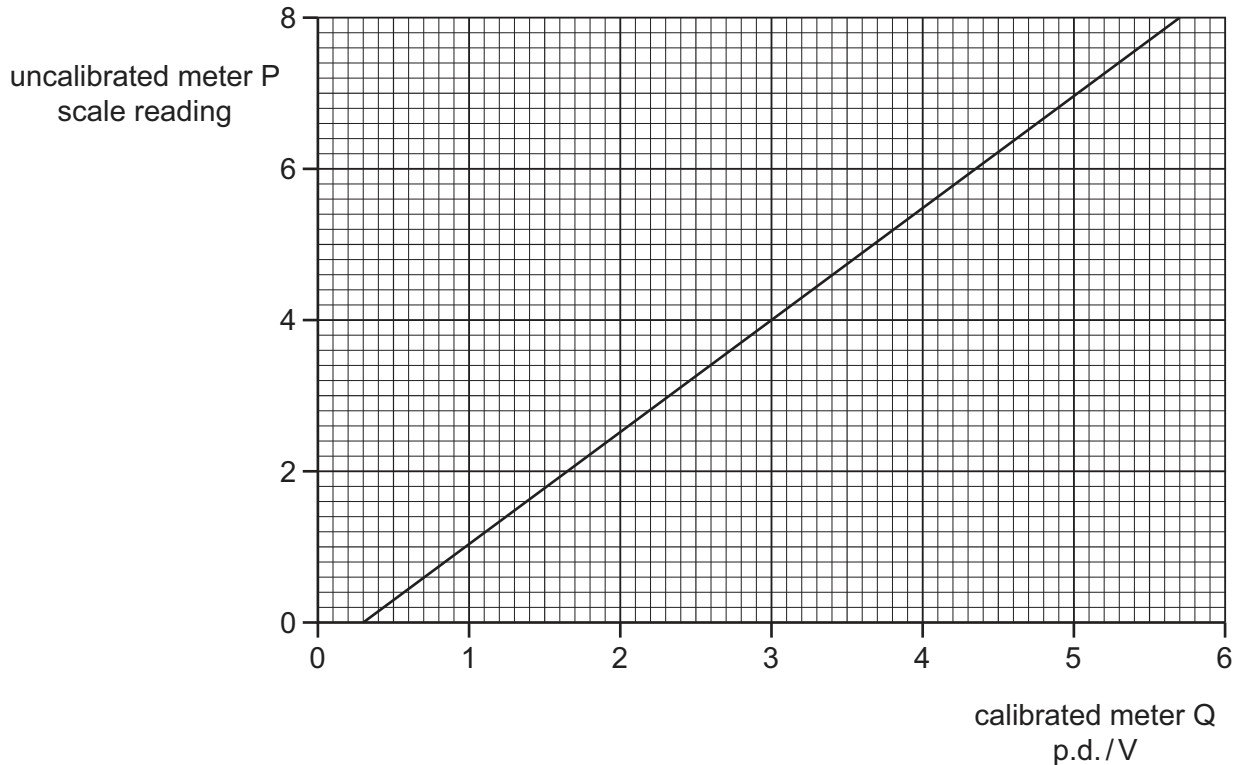

The graph shows that meter P has a zero error. This meter is now adjusted to remove this zero error. When the meter is recalibrated, the gradient of the calibration graph is found to be unchanged.

What is the new scale reading on meter P when it is used to measure a p.d. of 5.0 V?

- A** 6.6                      **B** 6.7                      **C** 7.2                      **D** 7.4

**Space for working**

- 6 A student wishes to determine the density  $\rho$  of lead. She measures the mass and diameter of a small sphere of lead:

$$\text{mass} = (0.506 \pm 0.005)\text{g}$$

$$\text{diameter} = (2.20 \pm 0.02)\text{mm}.$$

What is the best estimate of the percentage uncertainty in her value of  $\rho$ ?

- A 1.9%      B 2.0%      C 2.8%      D 3.7%
- 7 The graph shows how the velocity  $v$  of a firework rocket changes with time  $t$ .  
At which point on the graph does the rocket have the greatest acceleration?

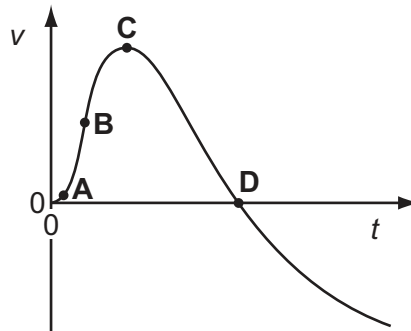

- 8 On a particular railway, a train driver applies the brake of the train at a yellow signal, a distance of 1.0 km from a red signal, where the train stops.

The maximum deceleration of the train is  $0.20\text{ m s}^{-2}$ .

Assuming uniform deceleration, what is the maximum safe speed of the train at the yellow signal?

- A  $14\text{ m s}^{-1}$       B  $20\text{ m s}^{-1}$       C  $40\text{ m s}^{-1}$       D  $400\text{ m s}^{-1}$

**Space for working**

- 9 A person, travelling on a motorway a total distance of 200 km, travels the first 90 km at an average speed of  $80 \text{ km h}^{-1}$ .

Which average speed must be obtained for the rest of the journey if the person is to reach the destination in a total time of 2 hours 0 minutes?

- A  $110 \text{ km h}^{-1}$     B  $120 \text{ km h}^{-1}$     C  $122 \text{ km h}^{-1}$     D  $126 \text{ km h}^{-1}$
- 10 A moving thorium nucleus  ${}^{230}_{90}\text{Th}$  spontaneously emits an  $\alpha$ -particle. The nucleus formed is a radium nucleus  ${}^{226}_{88}\text{Ra}$ , as shown.

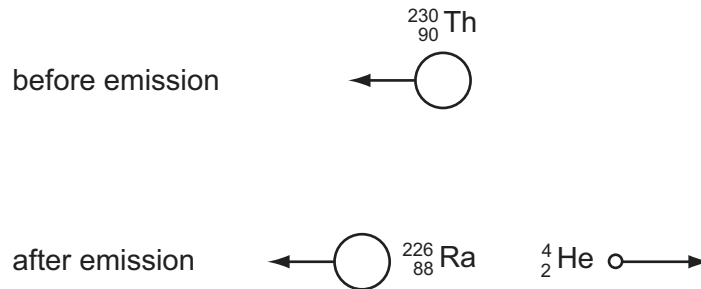

Which statement is correct?

- A The kinetic energy of the  $\alpha$ -particle equals the kinetic energy of the radium nucleus.  
 B The momentum of the  $\alpha$ -particle equals the momentum of the radium nucleus.  
 C The total momentum before the emission equals the total momentum after the emission.  
 D The velocity of the  $\alpha$ -particle equals the velocity of the radium nucleus.

**Space for working**



- 11 An isolated system consists of two bodies on which no external forces act. The two bodies collide with each other and stick together on impact.

Which row correctly compares the total kinetic energy and the total momentum of the bodies before and after the collision?

	total kinetic energy before and after the collision	total momentum before and after the collision
<b>A</b>	different	different
<b>B</b>	different	the same
<b>C</b>	the same	different
<b>D</b>	the same	the same

- 12 A mass accelerates uniformly when the resultant force acting on it

- A** is zero.  
**B** is constant but not zero.  
**C** increases uniformly with respect to time.  
**D** is proportional to the displacement from a fixed point.

- 13 A lead pellet of mass 10.0 g is shot horizontally into a stationary wooden block of mass 100 g. The pellet hits the block with an impact velocity of  $250 \text{ m s}^{-1}$ . It embeds itself in the block and it does not emerge.

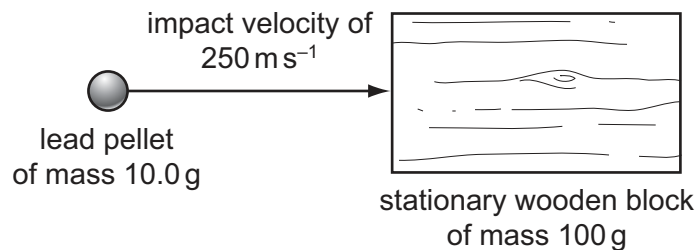

What will be the speed of the block immediately after the pellet is embedded?

- A**  $23 \text{ m s}^{-1}$       **B**  $25 \text{ m s}^{-1}$       **C**  $75 \text{ m s}^{-1}$       **D**  $79 \text{ m s}^{-1}$

**Space for working**

14 A cupboard is attached to a wall by a screw.

Which force diagram shows the cupboard in equilibrium, with the weight  $W$  of the cupboard, the force  $S$  that the screw exerts on the cupboard and the force  $R$  that the wall exerts on the cupboard?

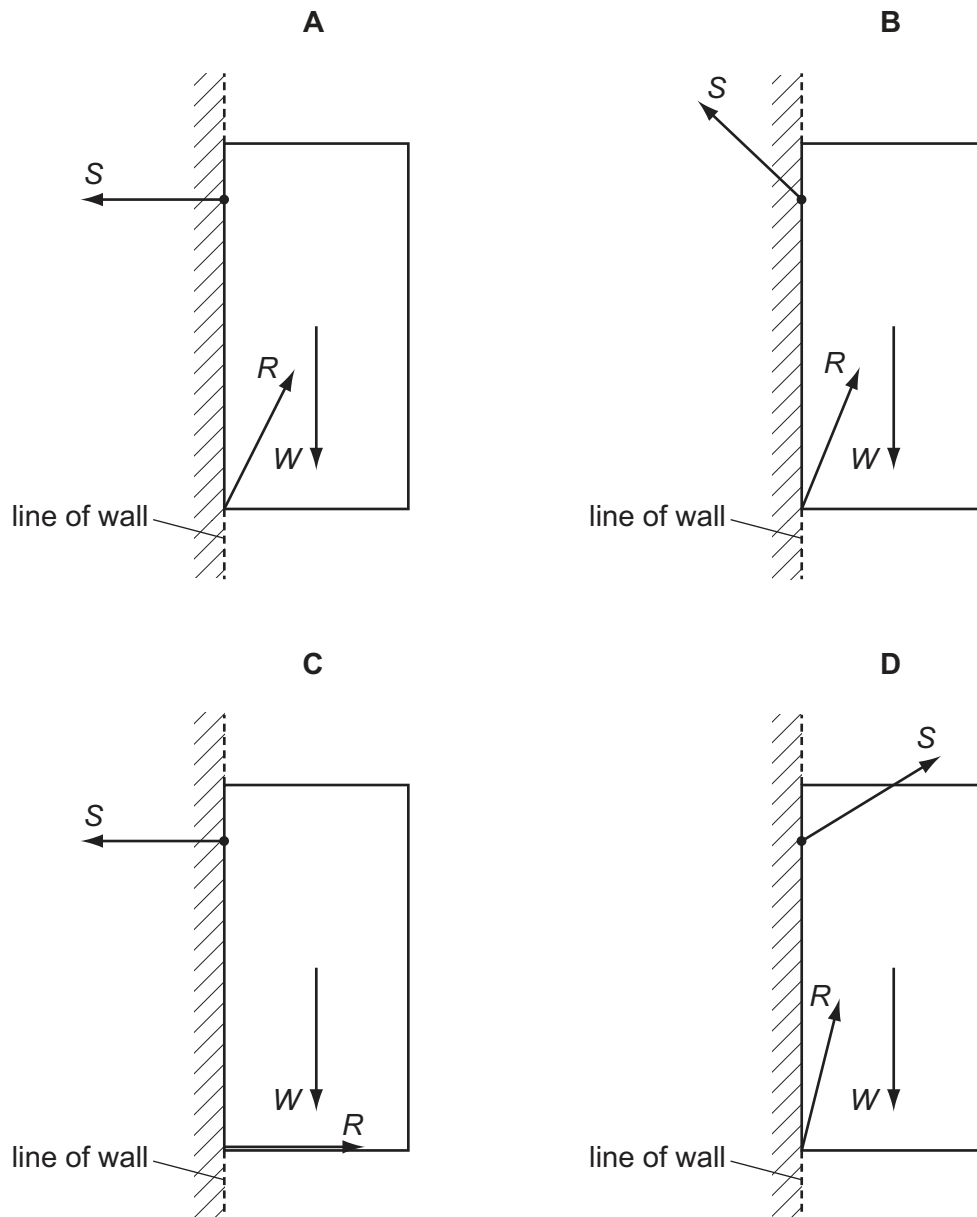

Space for working

- 15 A diving board of length 5.0 m is hinged at one end and supported 2.0 m from this end by a spring of spring constant  $10 \text{ kN m}^{-1}$ . A child of mass 40 kg stands at the far end of the board.

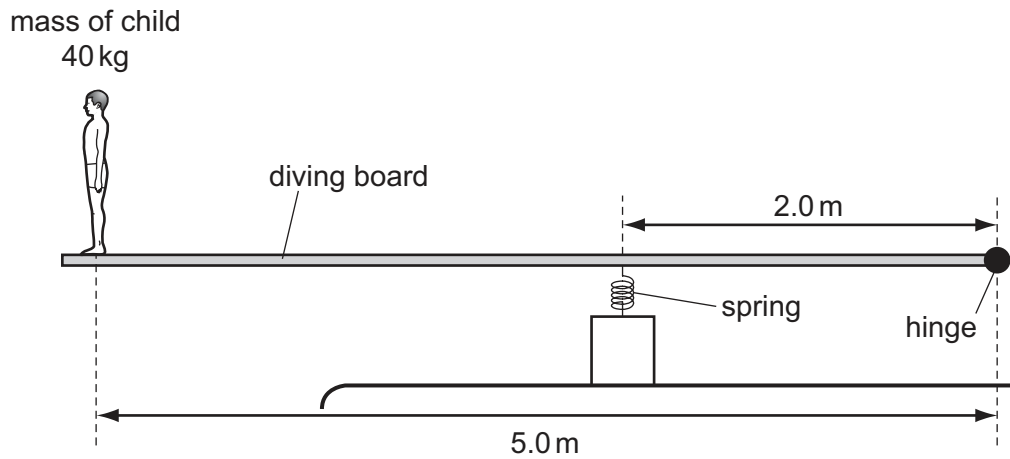

What is the extra compression of the spring caused by the child standing on the end of the board?

- A 1.0 cm      B 1.6 cm      C 9.8 cm      D 16 cm

**Space for working**

16 The graph shows how the total resistive force acting on a train varies with its speed.

Part of this force is due to wheel friction, which is constant. The rest is due to wind resistance.

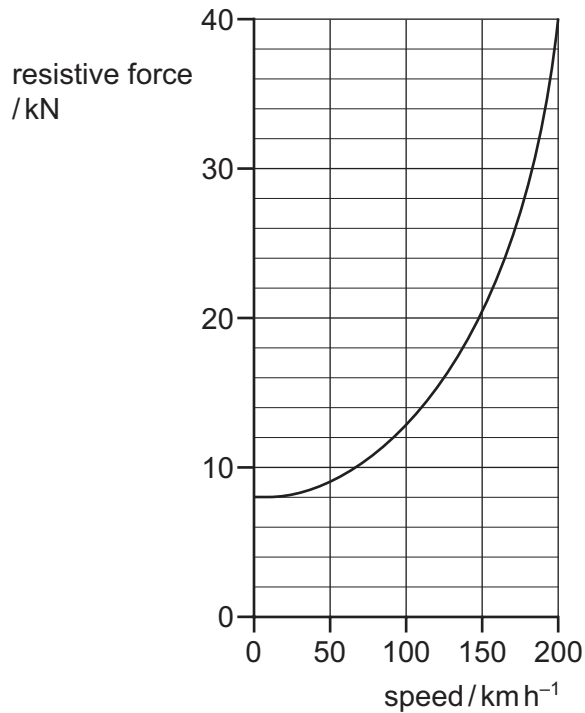

What is the ratio  $\frac{\text{wind resistance}}{\text{wheel friction}}$  at a speed of 200 km h<sup>-1</sup>?

- A** 4                      **B** 5                      **C** 8                      **D** 10

17 The pump of a water pumping system uses 2.0 kW of electrical power when raising water. The pumping system lifts 16 kg of water per second through a vertical height of 7.0 m.

What is the efficiency of the pumping system?

- A** 1.8%                      **B** 5.6%                      **C** 22%                      **D** 55%

18 A body travelling with a speed of 20 m s<sup>-1</sup> has kinetic energy  $E_k$ .

If the speed of the body is increased to 80 m s<sup>-1</sup>, what is its new kinetic energy?

- A**  $4E_k$                       **B**  $8E_k$                       **C**  $12E_k$                       **D**  $16E_k$

**Space for working**

- 19 An electrical generator is started at time zero. The total electrical energy generated during the first 5 seconds is shown in the graph.

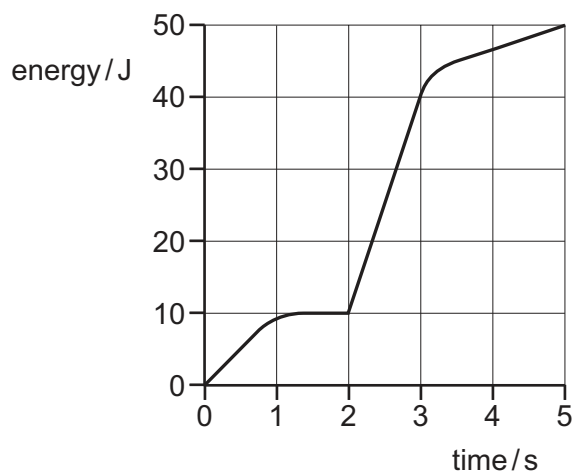

What is the maximum electrical power generated at any instant during these first 5 seconds?

- A** 10 W                      **B** 13 W                      **C** 30 W                      **D** 50 W
- 20 Gold has a density of  $19.3 \text{ g cm}^{-3}$ .

The volume occupied by a single atom of gold may be considered to be a cube with sides of length  $2.6 \times 10^{-8} \text{ cm}$ .

What is the mass of a gold atom?

- A**  $3.4 \times 10^{-25} \text{ g}$   
**B**  $3.4 \times 10^{-22} \text{ g}$   
**C**  $1.3 \times 10^{-17} \text{ g}$   
**D**  $1.3 \times 10^{-14} \text{ g}$

**Space for working**

- 21 In an experiment to demonstrate Brownian motion, a transparent container is filled with smoke particles suspended in air.

What can be seen when the contents of the container are strongly illuminated and viewed through a microscope?

- A molecules in random motion
  - B molecules vibrating regularly
  - C smoke particles in random motion
  - D smoke particles vibrating regularly
- 22 A lift is supported by two steel cables each of length 20 m.
- Each of the cables consists of 100 parallel steel wires, each wire of cross-sectional area  $3.2 \times 10^{-6} \text{ m}^2$ . The Young modulus of steel is  $2.1 \times 10^{11} \text{ N m}^{-2}$ .
- Which distance does the lift move downward when a man of mass 70 kg steps into it?
- A 0.010 mm      B 0.020 mm      C 0.10 mm      D 0.20 mm
- 23 What is equal to the Young modulus of a material that is extended elastically within the limit of proportionality?
- A area under the force-extension graph
  - B area under the stress-strain graph
  - C gradient of the force-extension graph
  - D gradient of the stress-strain graph

**Space for working**

- 24 Electromagnetic waves from an unknown source in space were found to be significantly diffracted when passing through gaps of the order of  $10^{-5}$  m.

Which type of wave are they most likely to be?

- A radio waves
- B microwaves
- C infra-red waves
- D ultraviolet waves

- 25 The graph shows how the height of the water surface at a point in a harbour varies with time  $t$  as waves pass the point.

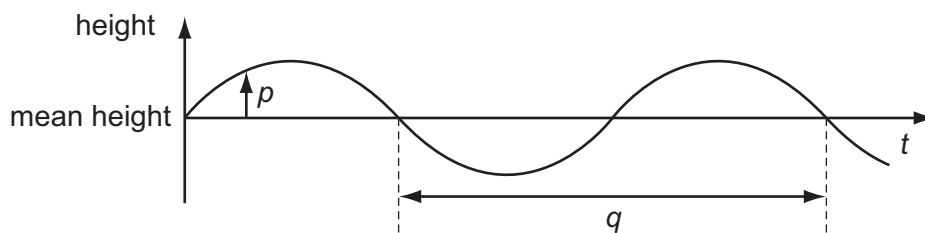

What are  $p$  and  $q$ ?

	$p$	$q$
A	displacement	period
B	displacement	wavelength
C	amplitude	period
D	amplitude	wavelength

Space for working

- 26 The three waves shown in each diagram have the same amplitude and frequency but differ in phase.

They are added together to give a resultant wave.

In which case is the resultant wave zero?

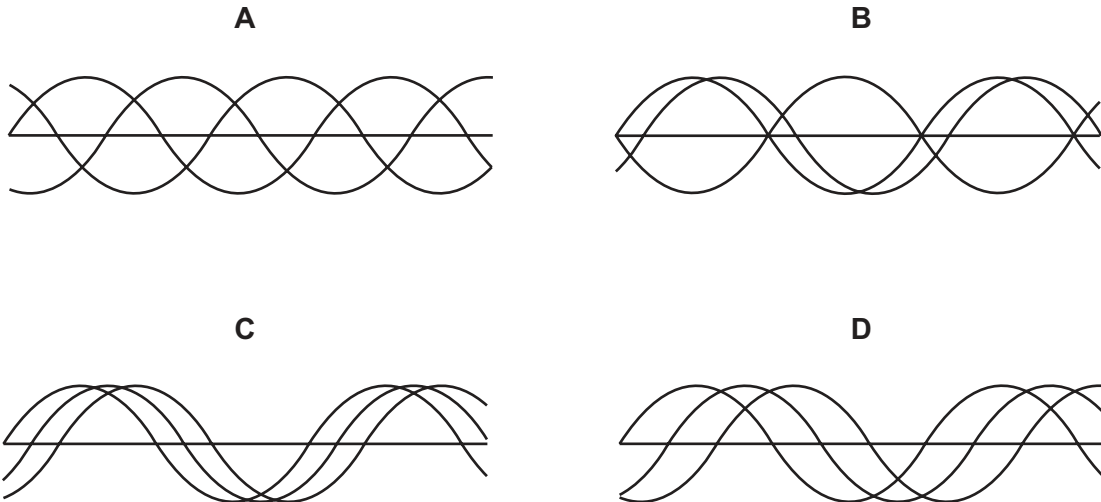

- 27 A stationary sound wave has a series of nodes. The distance between the first and the sixth node is 30.0 cm.

What is the wavelength of the sound wave?

- A** 5.0 cm      **B** 6.0 cm      **C** 10.0 cm      **D** 12.0 cm
- 28 What is meant by diffraction?
- A** Addition of two coherent waves to produce a stationary wave pattern.
  - B** Bending of waves round an obstacle.
  - C** Change of direction when waves cross the boundary between one medium and another.
  - D** Splitting of white light into colours.

**Space for working**



- 29 A student sets up apparatus to observe the double-slit interference of monochromatic light, as shown.

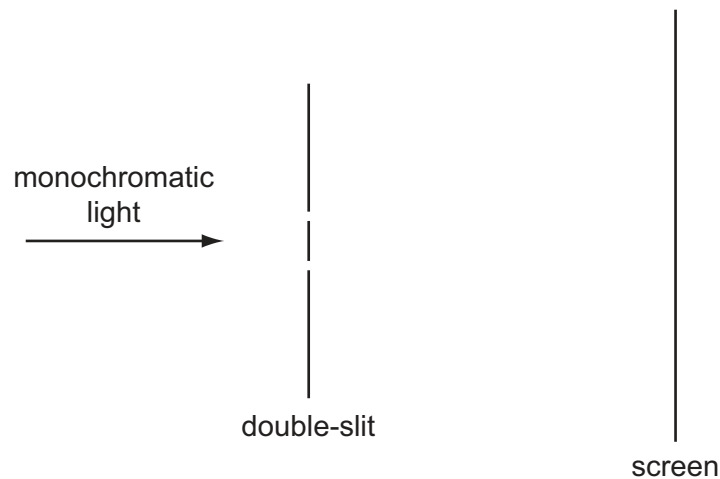

Interference fringes are formed on the screen.

Which change would increase the distance between adjacent fringes?

- A Decrease the distance between the two slits.
- B Decrease the width of each slit.
- C Move the screen closer to the double-slit.
- D Use light of a higher frequency.

**Space for working**

30 Two charged parallel metal plates produce an electric field.

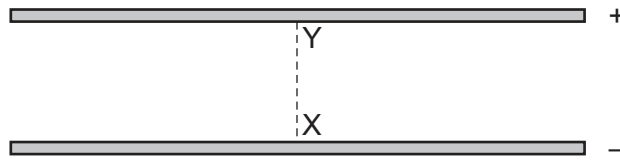

A charged particle moves from X to Y.

Which graph shows the variation of the force on the particle with distance from X along the line XY?

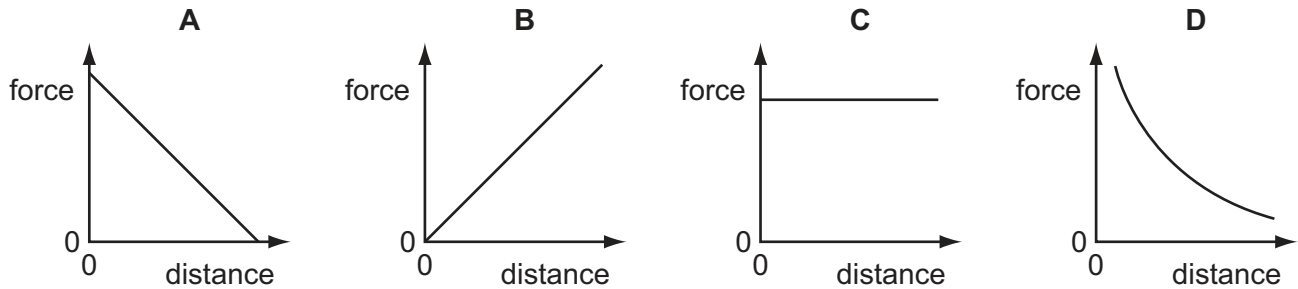

31 A small charge  $q$  is placed in the electric field of a large charge  $Q$ .

Both charges experience a force  $F$ .

What is the electric field strength of the charge  $Q$  at the position of the charge  $q$ ?

- A  $\frac{F}{Qq}$       B  $\frac{F}{Q}$       C  $FqQ$       D  $\frac{F}{q}$

32 The current in a component is reduced uniformly from 100 mA to 20 mA over a period of 8.0 s.

What is the charge that flows during this time?

- A 160 mC      B 320 mC      C 480 mC      D 640 mC

**Space for working**

- 33 An electric current is passed from a thick copper wire through a section of thinner copper wire before entering a second thick copper wire as shown.

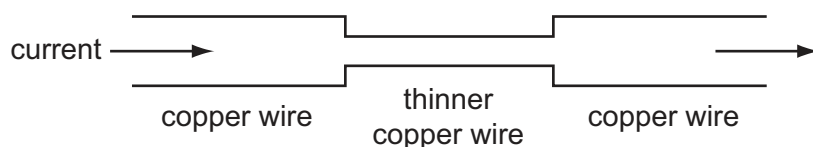

Which statement about the current and the speed of electrons in the wires is correct?

- A** The current and the speed of the electrons in the thinner wire are both less than in the thicker copper wires.
- B** The current and the speed of the electrons is the same in all the wires.
- C** The current is the same in all the wires but the speed of the electrons in the thinner wire is greater than in the thicker wires.
- D** The current is the same in all the wires but the speed of the electrons in the thinner wire is less than in the thicker wire.
- 34 An electrical device of fixed resistance  $20\Omega$  is connected in series with a variable resistor and a battery of electromotive force (e.m.f.)  $16\text{ V}$  and negligible internal resistance.

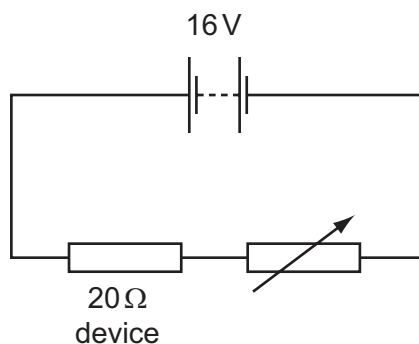

What is the resistance of the variable resistor when the power dissipated in the electrical device is  $4.0\text{ W}$ ?

- A**  $16\Omega$       **B**  $36\Omega$       **C**  $44\Omega$       **D**  $60\Omega$

**Space for working**

35 A copper wire is cylindrical and has resistance  $R$ .

What will be the resistance of a copper wire of twice the length and twice the radius?

- A  $\frac{R}{4}$                       B  $\frac{R}{2}$                       C  $R$                       D  $2R$

36 The diagram shows the electric motor for a garden pump connected to a 24 V power supply by an insulated two-core cable.

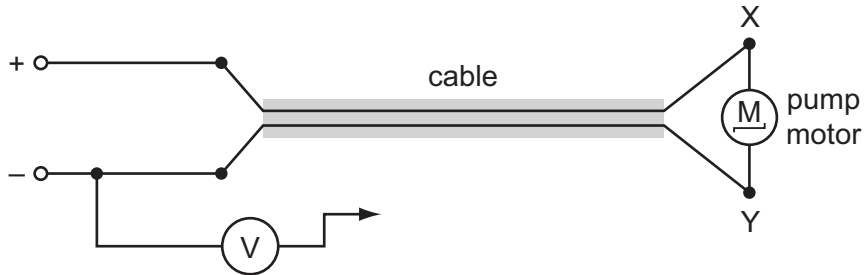

The motor does not work so, to find the fault, the negative terminal of a voltmeter is connected to the negative terminal of the power supply and its other end is connected in turn to terminals X and Y at the motor.

Which row represents two readings and a correct conclusion?

	voltmeter reading when connected to X/V	voltmeter reading when connected to Y/V	conclusion
<b>A</b>	24	0	break in positive wire of cable
<b>B</b>	24	12	break in negative wire of cable
<b>C</b>	24	24	break in connection within the motor
<b>D</b>	24	24	break in negative wire of cable

Space for working

37 In the circuit shown, the resistance of the thermistor decreases as temperature increases.

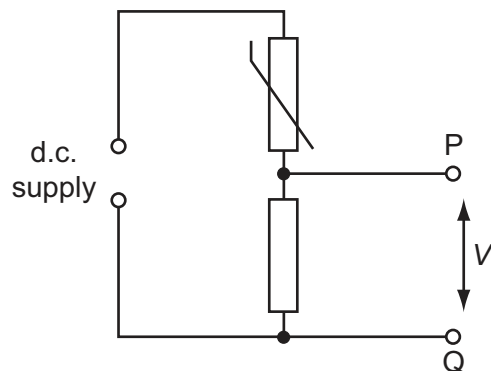

Which graph shows the variation with Celsius temperature  $\theta$  of potential difference  $V$  between points P and Q?

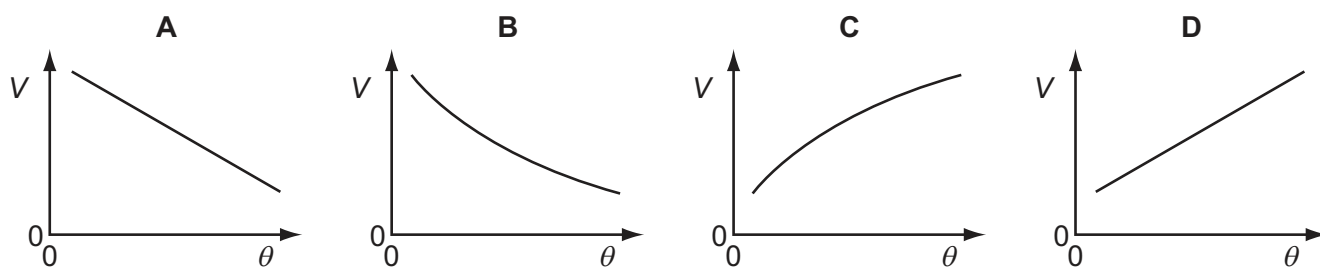

Space for working

- 38 A 20V d.c. supply is connected to a circuit consisting of five resistors L, M, N, P and Q.

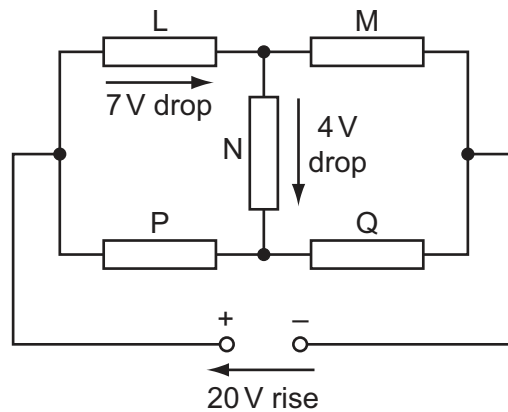

There is a potential drop of 7 V across L and a further 4 V potential drop across N.

What are the potential drops across M, P and Q?

	potential drop across M/V	potential drop across P/V	potential drop across Q/V
<b>A</b>	9	7	13
<b>B</b>	13	7	13
<b>C</b>	13	11	9
<b>D</b>	17	3	17

- 39 A nucleus of the nuclide  ${}_{89}^{228}\text{Ac}$  decays by emitting a beta particle. The nuclear equation below represents this decay.

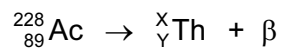

Which pair of values of X and Y is correct?

	X	Y
<b>A</b>	224	87
<b>B</b>	224	89
<b>C</b>	228	88
<b>D</b>	228	90

Space for working

40 Two  $\alpha$ -particles with equal energies are deflected by a large nucleus.

Which diagram best represents their paths?

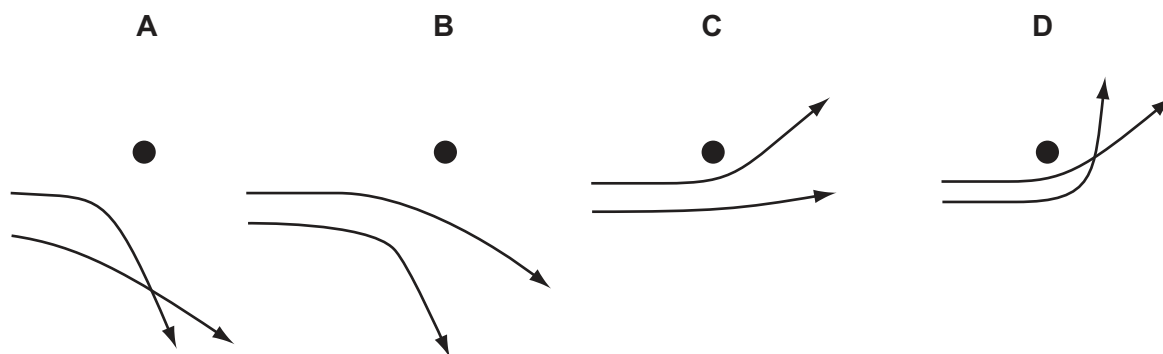

Space for working

---

Permission to reproduce items where third-party owned material protected by copyright is included has been sought and cleared where possible. Every reasonable effort has been made by the publisher (UCLES) to trace copyright holders, but if any items requiring clearance have unwittingly been included, the publisher will be pleased to make amends at the earliest possible opportunity.

Cambridge International Examinations is part of the Cambridge Assessment Group. Cambridge Assessment is the brand name of University of Cambridge Local Examinations Syndicate (UCLES), which is itself a department of the University of Cambridge.